

## Description

The smart power relay ESR10 Micro (Electronic Standard Relay) is a solid state relay which can replace electro-mechanical relays.

The ESR10 is a plus switching (high side switch) closing relay (NO) in an ISO Micro automotive relay enclosure.

It allows bipolar control by a positive voltage. This space-saving relay is available in three power classes:

- 10 A for max. 85° C / (12 and 24) Vdc
- 17 A for max. 105° C / (12 and 24) Vdc
- 30 A for max. 85° C / 12 Vdc

## Applications

The ESR10 helps to switch loads whose current demand is too high to be connected directly to the controlgear. The switching function of the ESR10 is completely noiseless. This allows installation in the vehicle's interior.

The ESR10 Micro is suitable for all applications in DC 12 V or 24 V electrical systems where valves, motors, lamps etc. have to be switched:

- Road vehicles (passenger cars, bicycles, trucks, buses, working vehicles and emergency cars, special vehicles)
- Construction vehicles and agricultural vehicles
- Watercraft (ships, sailing boats, motor yachts etc.)

## Benefits

- The low current consumption, particularly in the ON condition, helps to reduce gas consumption as well as CO<sub>2</sub> emissions.
- The solid state relay switches silently and features wear-free operation of all loads with an extremely long life span.

## Order numbering code

| Type No.      | Description  |
|---------------|--|
| ESR10         | electronic standard relay  |
| <b>N</b>      | <b>Protection (characteristic curve)</b><br>not protected, only short circuit protection |
| <b>C2</b>     | <b>Type of enclosure</b><br>Micro enclosure with hexagonal latching lugs                 |
| <b>C3</b>     | Micro design without retaining clip  |
| <b>A4</b>     | <b>Terminals (pins)</b><br>standard automotive, 4-pole (ISO)                             |
| <b>HB</b>     | <b>Load and control</b><br>high-side-switch (HSS), bipolar control                       |
| <b>00</b>     | <b>Sub type</b><br>standard  |
| <b>D1</b>     | <b>System voltage</b><br>DC 12 V   |
| <b>D2</b>     | DC 24 V  |
| <b>10 A</b>   | <b>Current rating (at 25°C)</b><br>10 A  |
| <b>17 A</b>   | 17 A   |
| <b>30 A *</b> | 30 A * (12 V only)   |

ESR10 - N C2 A4 HB - 00 - D1 - 10A ordering example

Please be informed that we have minimum ordering quantities to be observed.



ESR10 Micro

## Technical data (25 °C) – ESR10 Micro 10 A

### Voltage supply LINE+

|                              |                |                      |
|------------------------------|----------------|----------------------|
| System voltage               | U <sub>B</sub> | DC 12 V / DC 24 V    |
| Operating voltage            |                | 6...16 V / 10...32 V |
| Closed current <sup>1)</sup> | OFF            | 8 µA                 |

### Load circuit LOAD

|                            |                 |  |
|----------------------------|-----------------|--|
| Load output                |                 | MOSFET, high side switching (HSS)                        |
| Load types                 |                 | resistive, inductive and capacitive                      |
| Protective function        |                 | short circuit proof, temperature disconnection (pulsing) |
| Current rating             | I <sub>N</sub>  | 10 A   |
| Typical life               |                 | > 1,000,000 cycles                                       |
| Voltage drop <sup>1)</sup> | U <sub>ON</sub> | 75 mV  |
| Max. short circuit current |                 | 60 A (L/R = 3 ms)  |

### Control input IN+

|                                  |      |  |
|----------------------------------|------|--|
| Control voltage                  | ON   | 12 V: ±6...16 V; 24 V: ±10...32 V                        |
|                                  | OFF  | 12 V: ±0...2 V; 24 V: ±0...4 V                           |
| Control current <sup>1) 2)</sup> |      | 10 mA (at 13.5 V respectively 27 V) (derating see chart) |
| Switching frequency              | max. | see chart  |
| Rising edge                      |      | < 5 ms   |

### General data

|   |                    |   |
|---|--------------------|---|
| Reverse polarity protection circuit, load circuit | load               | yes (reverse polarity conductive) <sup>3)</sup> |
| Cycle times <sup>1)</sup>                         | t <sub>ON</sub>    | 0.5 ms  |
|   | t <sub>OFF</sub>   | 0.5 ms  |
| Temperature range                                 |                    | -40 °C...85 °C                                  |
| Dimensions  |                    | ISO Standard Micro (with retaining lugs)        |
|   | plugged in         | 26 x 15.5 x 26 mm                               |
|   | including contacts | 26 x 15.5 x 37 mm                               |
| Mass <sup>1)</sup>                                |                    | 15 g  |

<sup>1)</sup> typically

<sup>2)</sup> The upstream controlgear may misconstrue the situation as "wire break" due to the extremely low control current. In this case the trigger threshold should be adjusted.

<sup>3)</sup> In the event of reverse polarity connection, the MOSFET will switch through automatically for self-protection.

## Technical data (25 °C) – ESR10 Micro 17 A

| Voltage supply LINE+                              |                                     |   |
|---|-------------------------------------|---|
| System voltage                                    | U <sub>B</sub>                      | DC 12 V / DC 24 V   |
| Operating voltage                                 |                                     | 6...16 V / 10...32 V  |
| Closed current <sup>1)</sup>                      | OFF                                 | 8 µA  |
| Load circuit LOAD                                 |                                     |   |
| Load output                                       |                                     | MOSFET, high side switching (HSS)                                   |
| Load types  |                                     | resistive, inductive and capacitive                                 |
| Protective function                               |                                     | short circuit proof, temperature disconnection (pulsing)            |
| Current rating                                    | I <sub>N</sub>                      | 17 A  |
| Voltage drop <sup>1)</sup>                        | U <sub>ON</sub>                     | 75 mV   |
| Max. short circuit current                        |                                     | 100 A (L/R = 3 ms)  |
| Control input IN+                                 |                                     |   |
| Control voltage                                   | ON<br>OFF                           | 12 V: ±6...16 V; 24 V: ±10...32 V<br>12 V: ±0...2 V; 24 V: ±0...4 V |
| Control current <sup>1) 2)</sup>                  |                                     | 10 mA (at 13.5 V respectively 27 V) (derating see chart)            |
| Switching frequency                               | max.                                | see chart   |
| Rising edge                                       |                                     | < 5 ms  |
| General data                                      |                                     |   |
| Reverse polarity protection circuit, load circuit | load                                | yes (reverse polarity conductive) <sup>3)</sup>                     |
| Cycle times <sup>1)</sup>                         | t <sub>ON</sub><br>t <sub>OFF</sub> | 0.5 ms<br>0.5 ms  |
| Temperature range                                 |                                     | -40 °C...105 °C   |
| Dimensions  |                                     | ISO Standard Micro (with retaining lugs)                            |
| plugged in  |                                     | 26 x 15.5 x 26 mm   |
| including contacts                                |                                     | 26 x 15.5 x 37 mm   |
| Mass <sup>1)</sup>                                |                                     | 15 g  |

## Technical data (25 °C) – ESR10 Micro 30 A

| Voltage supply LINE+                              |                                     |  |
|---|-------------------------------------|--|
| System voltage                                    | U <sub>B</sub>                      | DC 12 V  |
| Operating voltage                                 |                                     | 6...16 V   |
| Closed current <sup>1)</sup>                      | OFF                                 | 5 µA   |
| Load circuit LOAD                                 |                                     |  |
| Load output                                       |                                     | MOSFET, high side switching (HSS)                        |
| Load types  |                                     | resistive, inductive and capacitive                      |
| Protective function                               |                                     | short circuit proof, temperature disconnection (pulsing) |
| Current rating                                    | I <sub>N</sub>                      | 30 A   |
| Voltage drop <sup>1)</sup>                        | U <sub>ON</sub>                     | 50 mV  |
| Max. short circuit current                        |                                     | 100 A (L/R = 3 ms)                                       |
| Control input IN+                                 |                                     |  |
| Control voltage                                   | ON<br>OFF                           | 12 V: ±6...16 V<br>12 V: ±0...2 V                        |
| Control current <sup>1) 2)</sup>                  |                                     | 10 mA (at 13.5 V respectively 27 V) (derating see chart) |
| Switching frequency                               | max.                                | see chart  |
| Rising edge                                       |                                     | < 5 ms   |
| General data                                      |                                     |  |
| Reverse polarity protection circuit, load circuit | load                                | yes (reverse polarity conductive) <sup>3)</sup>          |
| Cycle times <sup>1)</sup>                         | t <sub>ON</sub><br>t <sub>OFF</sub> | 0.5 ms<br>3.5 ms   |
| Temperature range                                 |                                     | -40 °C...85 °C   |
| Dimensions  |                                     | ISO Standard Micro (with retaining lugs)                 |
| plugged in  |                                     | 26 x 15.5 x 26 mm  |
| including contacts                                |                                     | 26 x 15.5 x 37 mm  |
| Mass <sup>1)</sup>                                |                                     | 15 g   |

**Important:** The 30A version of the ESR10 Micro will only be available upon request and for high volume projects (> 5000 pcs). Small quantities cannot be ordered.

## Approvals

| Authority | Approval mark | Regulation |
|-----------|---------------|------------|
| KBA       | E1            | ECE R 10   |

## Qualifications

|  |
|--|
| <b>ESR10 Micro 10 A/12 V variant, VW</b>   |
| VW80000:2013-06 (LV124)<br>TL81000:2013-02                                       |
| <b>ESR10 Micro 10 A/12 V variant, GM</b>   |
| GMW 15267<br>GMW 3097  |
| <b>ESR10 Micro 10 A, 17 A, 30 A / 24 V</b>                                       |
| Environmental tests to LV124<br>(Specification and severity to VW80000: 2013-06) |
| Electrical tests to ISO 16750-2  |

## Tests

|                      |   |
|----------------------|---|
| Chemical resistance  | Tested with battery acid, interior cleaner, glass cleaner, acetone, spirit, cream, caffeine and sugar containing drink. |
| Vibration            | ISO 60068-2-64:2008 test FH 30g   |
| Shock                | ISO 60068-2-27:2009 test EA 50g   |
| Free fall            | Drop height 1m onto concrete  |
| Salt spray           | DIN EN 60068-2-11:2000 Test KA  |
| Degree of protection | ISO 20653 2nd Edition:2013/IEC 60068-2-68:1997 IP5K3  |

## Pin assignment

| ESR10 Micro     |   |         |                |
|-----------------|---|---------|----------------|
| LINE +          | 3 | (30)    | U <sub>B</sub> |
| IN <sub>a</sub> | 1 | (86/31) | control input  |
| IN <sub>b</sub> | 2 | (31/86) | ground         |
| LOAD            | 5 | (88a)   | load output    |

( ) <sup>^</sup> = Automotive terminal designation

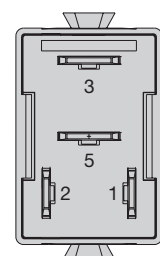

Dimensions

Pin assignment is in accordance with ISO 7588  
 3 and 5 – blade terminals 6.3 x 0.8 [mm]  
 1 and 2 – blade terminals 4.8 x 0.8 [mm]

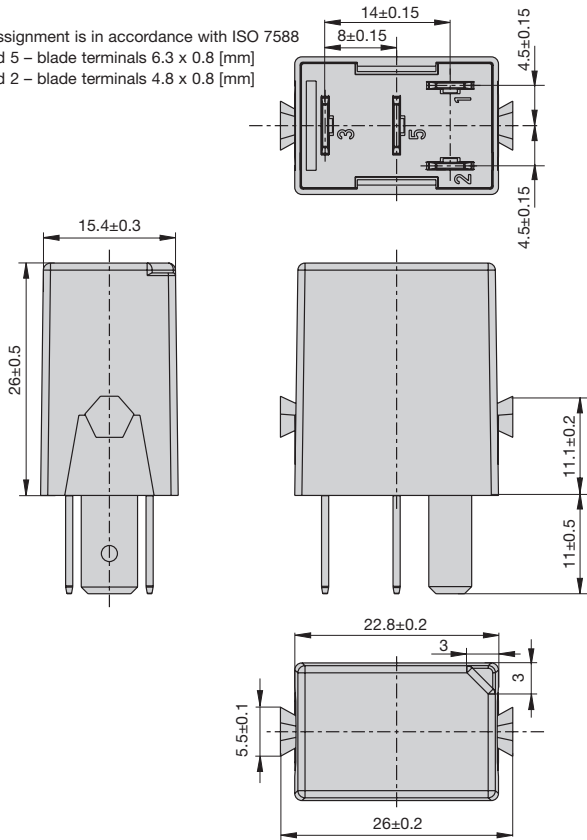

Dimensions: Design without retaining clip

Pin assignment is in accordance with ISO 7588  
 3 and 5 – blade terminals 6.3 x 0.8 [mm]  
 1 and 2 – blade terminals 4.8 x 0.8 [mm]

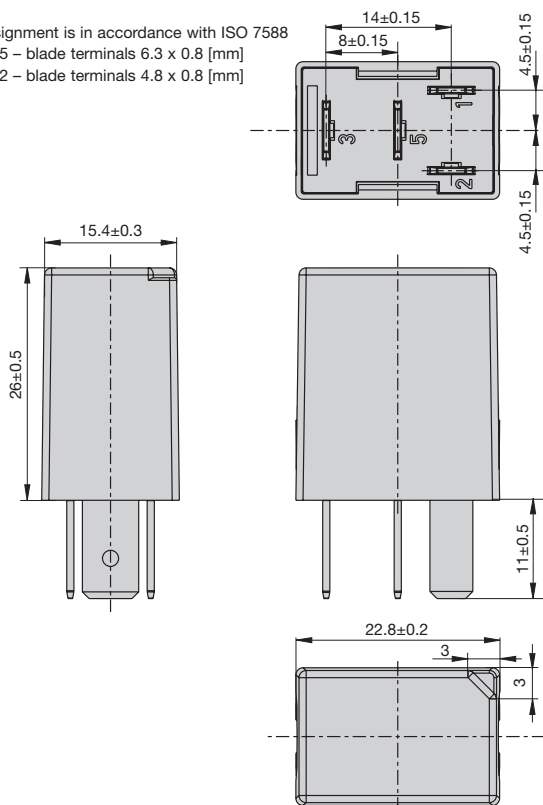

Schematic diagram

Alternative control of bipolar control inputs

| Control inputs | IN a           | IN b           |
|----------------|----------------|----------------|
| alternative 1  | U <sub>B</sub> | GND            |
| alternative 2  | GND            | U <sub>B</sub> |

alternative 1

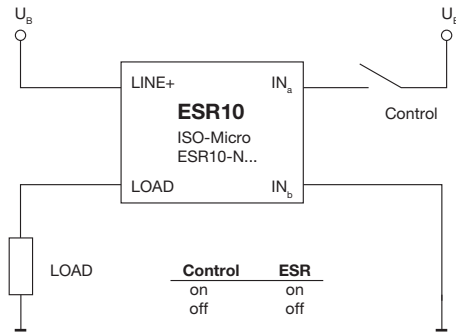

alternative 2

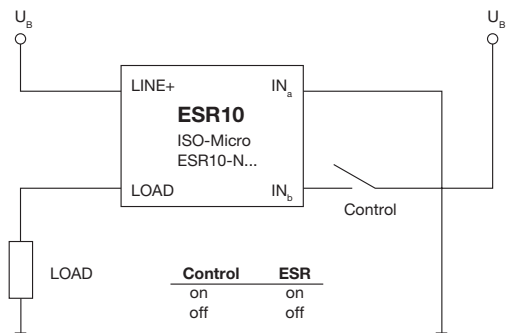

All dimensions without tolerances are for reference only. E-T-A reserves the right change specifications at any time in the interest of improved design, performance and cost effectiveness, the right to make changes in these specifications without notice is reserved. Product markings may not be exactly as the ordering codes. Errors and omissions excepted.

**Derating**

Load current for – 10 A variant

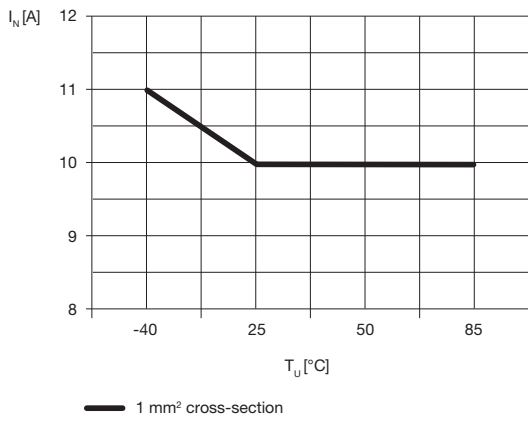

Load current for – 30 A variant

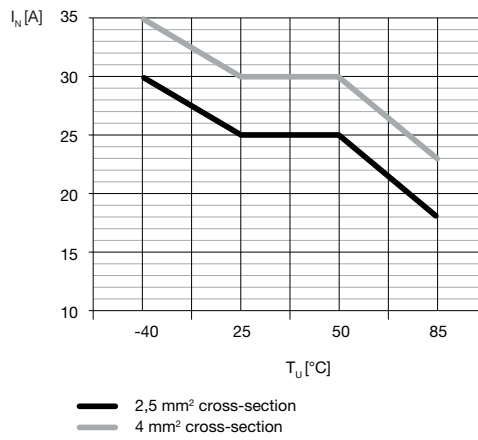

Load current for 17 A variant

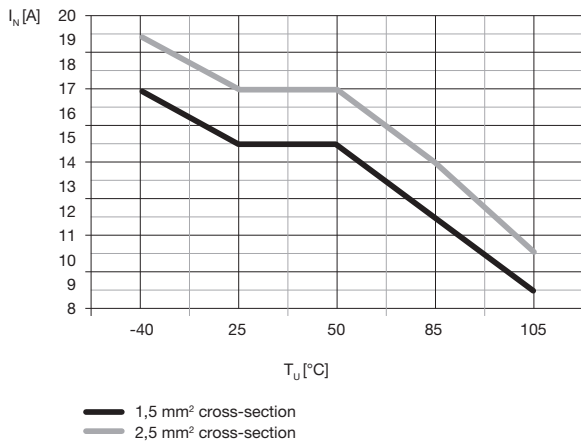

Control current for 12 V – 10 A / 17 A / 30 A variant

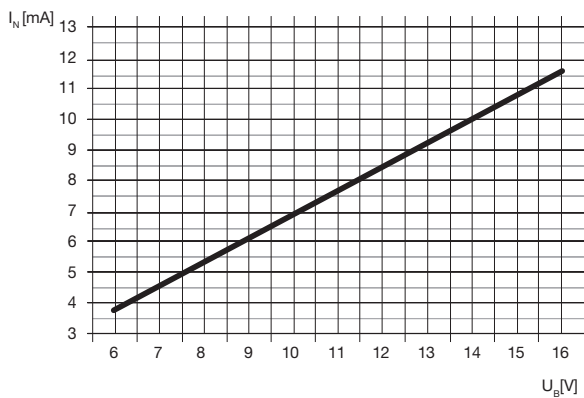

Control current for 24 V – 10 A / 17 A / 30 A variant

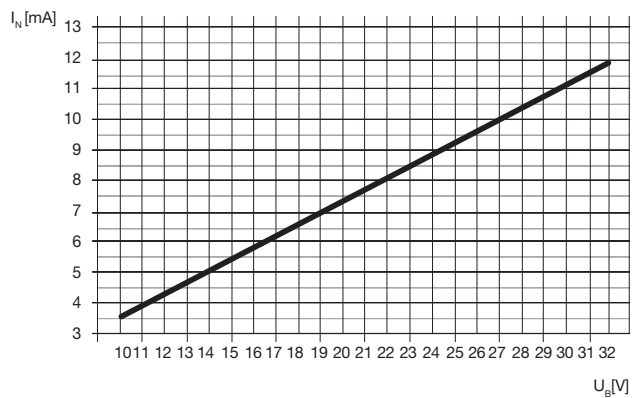

5

Frequency control 10 A

10 A / 12 V variant

Frequency measurement with 100 Hz

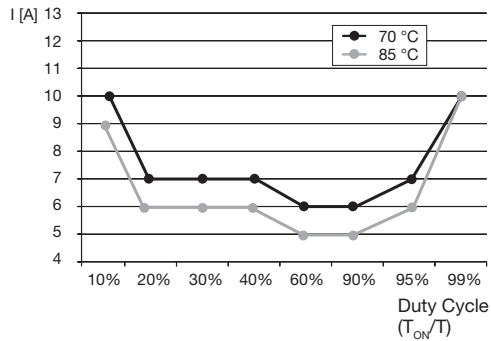

10 A / 24 V variant

Frequency measurement with 50 Hz

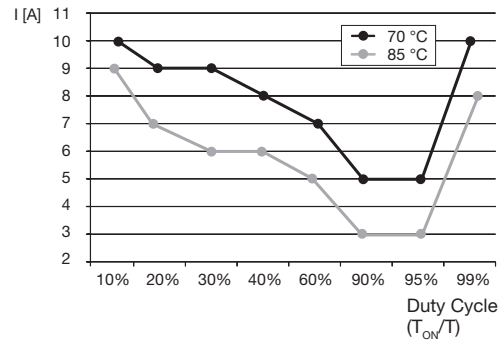

Frequency measurement with 150 Hz

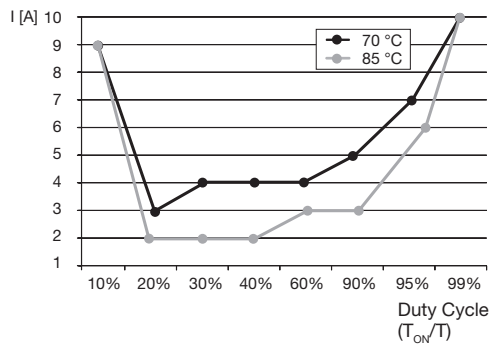

Frequency measurement with 100 Hz

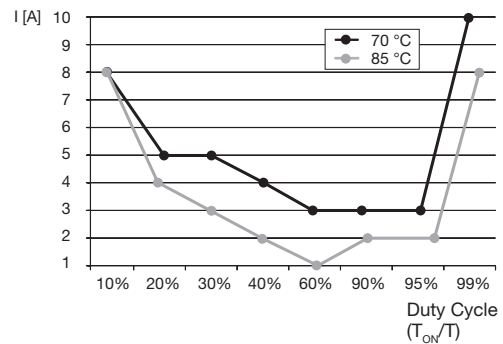

Frequency measurement with 200 Hz

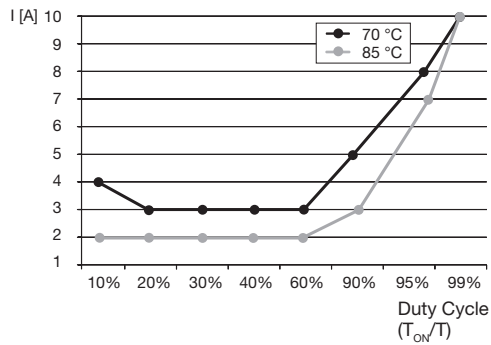

The max. load current depends on the load type. Please contact the manufacturer of the load if the limit values shown above are reached. E-T-A is able to test whether the relay works in the limit range.

Frequency control 17 A / 30 A

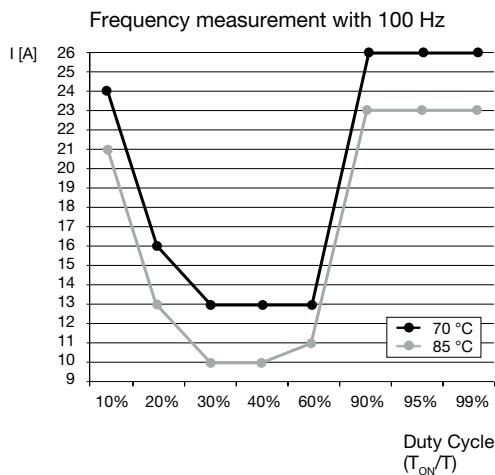
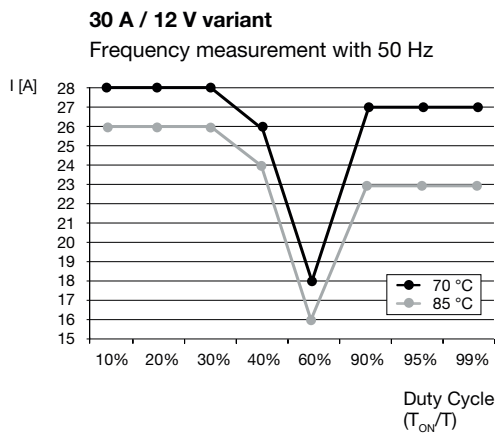
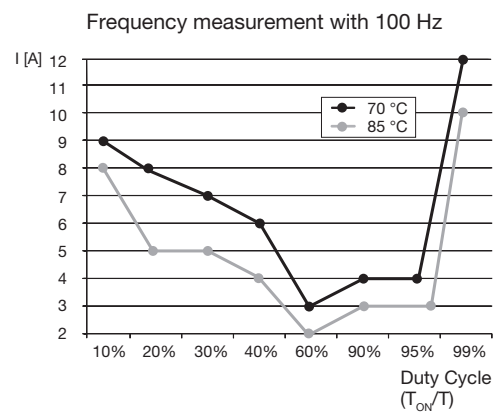
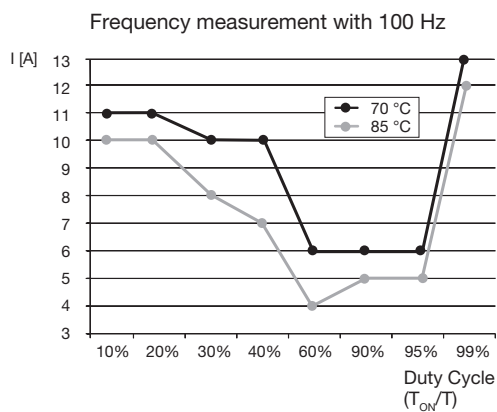
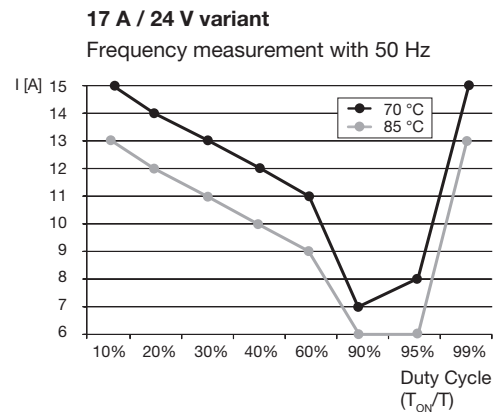
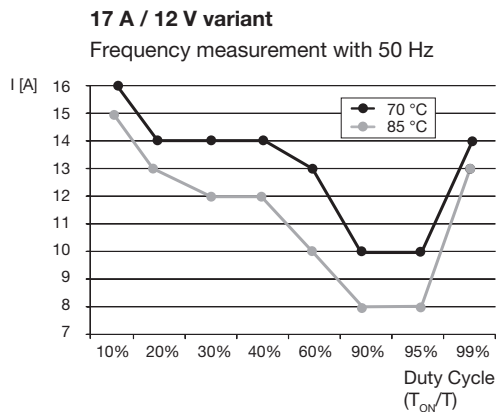

The max. load current depends on the load type. Please contact the manufacturer of the load if the limit values shown above are reached. E-T-A is able to test whether the relay works in the limit range.

5