

## Description

The electronic circuit breaker type ESS22-T extends the E-T-A product range of electronic circuit protection for DC 24 V applications. It is a double pole version providing physical isolation. It meets the requirements of the machinery directive 2006/42/EC and the affiliated standard EN 60204-1 "Safety of Machinery, Electrical Equipment of Machines", para 9.4.3.1.

The combination of active electronic current limitation in the event of a short circuit and overload disconnection from 1.1 times rated current provides double pole selective protection of DC 24 V load systems.

DC 24 V power supplies, which are widely used in industry today, will shut down the output in the event of an overload with the result that one faulty load in the system can lead to complete disconnection of all loads. As well as an unidentified failure this also means stoppage of the whole system.

Through selective disconnection the ESS22-T responds much faster to overload or short circuit conditions than the switch-mode power supply. This is achieved by active current limitation. The ESS22-T limits the highest possible current to typically 1.4 times the selected rated current. Thus it is possible to switch on capacitive loads of up to 20,000 µF, but they are disconnected only in the event of an overload or short circuit.

For optimal alignment with the characteristics of the application the current rating of the ESS22-T can be selected in fixed values from 0.5 A...10 A. Failure and status indication are by a multicolour LED and integral signal contacts. Remote operation is possible by means of a physically isolated control input. The manual ON/OFF button allows separate actuation of individual load circuits.

The ESS22-T, with a width of only 22.5 mm, can be snapped onto symmetrical rails ensuring ease of installation and saving space in control cabinets.

Upon detection of overload or short circuit in the load circuit, the MOSFET of the load output will be blocked to interrupt the current flow. In addition the load output will be physically isolated by a mechanical switching element. Upon failure remedy the load output of the ESS22-T is re-activated manually by operating the ON/OFF switch on the device or optionally by the physically isolated reset input and/or the control input.

**US patent number:** US 6,490,141 B2

## Features

- Double pole electronic circuit breaker with physical isolation at load output
- Double protection of "load+ path" through electronic protection and failsafe element
- Double protection of "load- path" through electronic protection and failsafe element
- Selective load protection, electronic trip curve
- Active current limitation for safe connection of capacitive loads up to 20,000 µF, DC motors and on overload/short circuit
- Fixed current ratings 0.5 A...10 A
- Low voltage monitoring
- Manual ON/OFF button
- Physically isolated control input for ON/OFF optional
- Physically isolated reset input RE optional
- Clear status and failure indication through multicolour LED
- Two signal contacts (break contact and make contact)
- Width per unit 22.5 mm
- Rail mounting

## Approvals

Authority	Standard	Rated voltage	Current ratings
VDE	EN 60934	DC 32 V	0.5 A...10 A
UL	UL 1077 C22.2 No 235	DC 30 V	0.5 A...10 A



ESS22-T

## Technical data (T<sub>ambient</sub> = 25 °C, operating voltage U<sub>S</sub> = DC 24 V)

### Operating data

Operating voltage U <sub>S</sub>	DC 24 V (18...32 V)
Current rating I <sub>N</sub>	fixed current ratings: 0.5 A, 1 A, 2 A, 3 A, 4 A, 6 A, 8 A, 10 A
Closed current I <sub>0</sub>	ON condition: typically 27 mA with signal output: typically 37 mA
Status indication by means of	<ul style="list-style-type: none"> <li>• multicolour LED:                             <ul style="list-style-type: none"> <li><b>GREEN:</b> <ul style="list-style-type: none"> <li>- unit is ON, load circuit switched on</li> </ul> </li> <li><b>ORANGE:</b> <ul style="list-style-type: none"> <li>- in the event of overload or short circuit until disconnection</li> </ul> </li> <li><b>RED:</b> <ul style="list-style-type: none"> <li>- after overload/short circuit disconnection</li> <li>- upon low voltage in ON condition</li> <li>- after switch-on till the end of the ON delay period</li> </ul> </li> <li><b>OFF:</b> <ul style="list-style-type: none"> <li>- switched off by means of switch or control input</li> <li>- no operating voltage applied</li> </ul> </li> </ul> </li> <li>• potential-free signal contact</li> <li>• ON/OFF condition of switch</li> </ul>

### Load circuit

Load output	Power-MOSFET and relay switching output with physical isolation, plus- and minus-switching
Overload disconnection	typically 1.1 x I <sub>N</sub> (1.05...1.35 x I <sub>N</sub> )
Short-circuit current I <sub>K</sub>	active current limitation typically 1.4 x I <sub>N</sub> (see table 1)
Trip times	see time/current characteristics typically 3 s at I <sub>Load</sub> > 1.1 x I <sub>N</sub> typically 100 ms...3 s at I <sub>Load</sub> > 1.4 x I <sub>N</sub>
Temperature disconnection	internal temperature monitoring with electronic disconnection
Low voltage monitoring	OFF at typically < 16.0 V ON at typically > 17.5 V automatic switch ON or OFF
Starting delay t <sub>Start</sub>	typically 0.5 sec after every switch-on, after reset and after applying U <sub>S</sub>
Disconnection of load circuit	double pole, with physical isolation <ul style="list-style-type: none"> <li>- manually on the breaker via ON/OFF switch (OFF)</li> <li>- after overload/short circuit disconnection</li> <li>- via external control input</li> <li>- at low voltage</li> <li>- no operating voltage applied</li> </ul>

## Technical data (T<sub>ambient</sub> = 25 °C, operating voltage U<sub>S</sub> = DC 24 V)

Reset after overload or short circuit disconnection	<ul style="list-style-type: none"> <li>- remedy the external overload or short circuit failure</li> <li>- manual RESET on the breaker via ON/OFF switch</li> <li>- no reset with voltage interruptions (status memory)</li> <li>- no reset possible via external control input IN</li> <li>- external reset optionally possible via reset input RE</li> </ul>
Free-wheeling circuit	external free-wheeling diode recommended with inductive load
Load outputs must not be connected in parallel	
<b>Status output SF</b>	<b>ESS22-TA-0x1</b>
Electrical data	potential-free signal contact 1 break contact, terminal 11-12 (closed in OFF or failure condition) 1 make contact, terminal 13-14 (open in OFF or failure condition) max. DC 30 V / 0.5 A, min. 10 V / 10 mA
Fault	signal output fault conditions: - ON/OFF switch is in OFF position (manually) - after overload/short circuit disconnection - external control input (OFF) - low voltage - no operating voltage U <sub>S</sub>
<b>Control input IN+/IN-</b>	<b>ESS22-TA-01x / ESS22-TA-03x</b>
Electrical data	control input (IN+/IN-) is physically isolated from load circuit (optocoupler) voltage max. + DC 32 V high > DC 12 V ≤ DC 32 V (switch on) low ≤ DC 5 V > 0 V (switch off) current consumption typically 3...9 mA (DC +12 V...32 V)
Reset function	<b>ESS22-TA-03x</b> A non-conducting load output (after an overload/short circuit disconnection) can be reset externally via the control input. In order to do that the control input has to be switched off for >100 ms
Links	manual ON/OFF switch on breaker is linked to the external control input IN+ by means of an AND function
<b>Reset input RE+ / RE-</b>	<b>ESS22-TA-02x</b>
Electrical data	reset input (RE+ / RE-) physically isolated from load circuit (optocoupler) voltage: max. + DC 32 V high > DC 12 V ≤ DC 32 V low ≤ DC 5 V > 0 V power consumption typically 3...9 mA (DC +12 V...32 V) min. pulse duration for RESET 100 ms
Reset signal RE	The electronically blocked load output (blocked after overload/short circuit disconnection) may be reset via an external reset pulse (+ DC 24 V). A common reset signal can be applied to several devices simultaneously. RESET - pulse/edge from low (min. 100 ms) to high (min. 100 ms)
<b>General data</b>	
Fail-safe element	failsafe element aligned to rated current (back-up fuse)

## Technical data (T<sub>ambient</sub> = 25 °C, operating voltage U<sub>S</sub> = DC 24 V)

<b>Terminals</b>	
Screw terminals	M3
Max. cable cross section	
Rigid / flexible	0.14 – 2.5 mm <sup>2</sup> (AWG 26-14)
Wire stripping length	8 mm
Tightening torque (EN 60934)	0.5 – 0.6 Nm
Loop through option	redundant LINE and LOAD terminals, max. cont. load for line entry 10 A
Housing material	moulded
Mounting	symmetrical rail to EN 50022-35x7.5
Ambient temperature	0...+50 °C (without condensation, see EN 60204-1)
Storage temperature	-20...+70 °C
Humidity	96 hrs/95 % RH/40 °C to IEC 60068-2-78, test Cab. climate class 3K3 to EN 60721
Vibration	3 g, test to IEC 60068-2-6 test Fc
Degree of protection	housing: IP20 DIN 40050 terminals: IP20 DIN 40050
Standards, directives	CE logo to EMC directive emitted interference: EN 61000-6-3 immunity to interference: EN 61000-6-2 surge voltages: EN 61000-4-5
Insulation co-ordination (IEC 60934)	0.5 kV/2 pollution degree 2
Insulation voltage	DC 500 V between the physically isolated areas: load circuit in OFF condition, signal input and signal outputs
Dielectric strength	max. DC 32 V
Reverse polarity protection	integral
Dimensions	see following page (tolerances to DIN ISO 268 part 1 ± IT 13)
Mass	approx. 110 g

**Table 1: voltage drop, current limitation, max. load current**

current rating I <sub>N</sub>	typically voltage drop U <sub>ON</sub> at I <sub>N</sub>	active current limitation (typically)	max. load current at 100 % ON duty	
			T <sub>amb</sub> = 40 °C	T <sub>amb</sub> = 50 °C
0.5 A	80 mV	1.4 × I <sub>N</sub>	0.5 A	0.5 A
1 A	110 mV	1.4 × I <sub>N</sub>	1 A	1 A
2 A	140 mV	1.4 × I <sub>N</sub>	2 A	2 A
3 A	100 mV	1.4 × I <sub>N</sub>	3 A	3 A
4 A	130 mV	1.4 × I <sub>N</sub>	4 A	4 A
6 A	180 mV	1.4 × I <sub>N</sub>	6 A	6 A
8 A	130 mV	1.4 × I <sub>N</sub>	8 A	7 A
10 A	170 mV	1.4 × I <sub>N</sub>	10 A	9 A

**Attention:** when mounted side-by-side without convection the ESS22-T should not carry more than 80 % of its rated load with 100 % ON duty due to thermal effects.

## Ordering information

### Type No.

**ESS22** double pole electronic circuit breaker, with current limitation

### Mounting and design

**TA** rail mounting, with ON/OFF switch

### Version

**0** with double pole physical isolation at load output

### Signal input

**0** without signal input

**1** with control input IN-/IN+; without reset function upon overload

**2** with reset input RE-/RE+

**3** with control input IN-/IN+; with reset function upon overload (only for ESS22-TA-xxx)

### Signal output

**0** without signal output (only for version **TA-00**)

**1** signal contacts: 1 make contact, 1 break contact

### Operating voltage

**DC 24 V** rated voltage DC 24 V

### Current rating

**0.5 A**

**1 A**

**2 A**

**3 A**

**4 A**

**6 A**

**8 A**

**10 A**

**ESS22 - TA - 0 0 1 - DC 24 V 4 A** ordering example

### Please note:

- The user should ensure that the cable cross sections of the relevant load circuit are suitable for the current rating of the ESS22-T used.
- Automatic start-up of machinery after shut down must be prevented (Machinery Directive 98/37/EG and EN 60204-1). In the event of a short circuit or overload the ESS22-T ensures double pole physical isolation of the load circuit.

## Preferred types

Preferred types	Standard current ratings (A)							
	0.5	1	2	3	4	6	8	10
ESS22-TA-001-DC24V	x	x	x	x	x	x	x	x

## Schematic diagram ESS22-TA-011

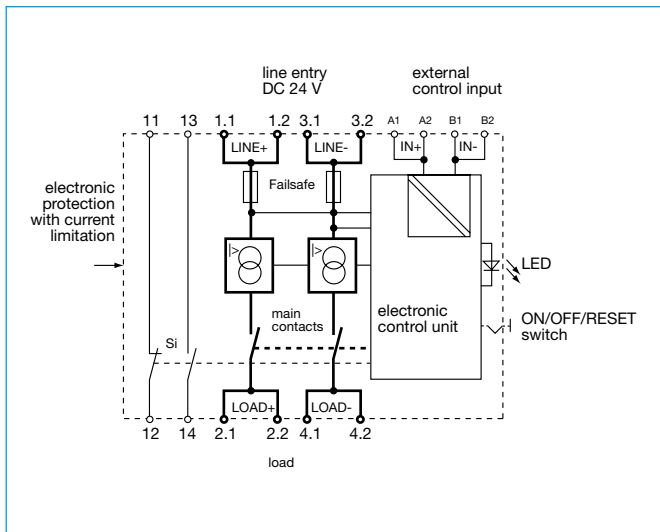

## Time/Current characteristic curve ( $T_A = 25^\circ\text{C}$ )

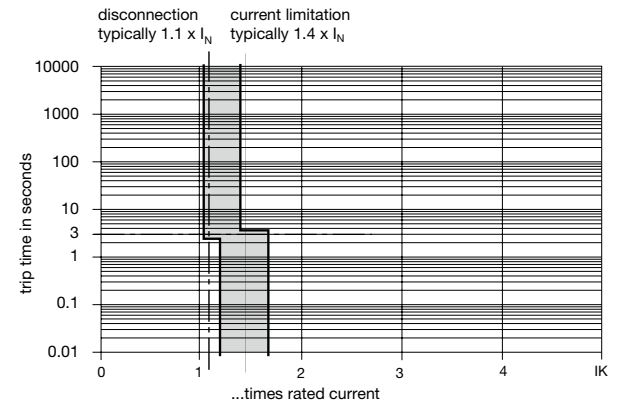

- The trip time is typically 3 s in the range between 1.1 and 1.4 x  $I_N$
- Electronic current limitation occurs at typically 1.4 x  $I_N$  which means that under all overload conditions (independent of the power supply and the resistance of the load circuit) the max. overload before disconnection will not exceed 1.4 x  $I_N$  times the current rating. Trip time is between 100 ms and 3 sec (depending on overload or at short circuit).
- Without this current limitation a considerably higher overload current would flow in the event of an overload or short circuit.

## Dimensions

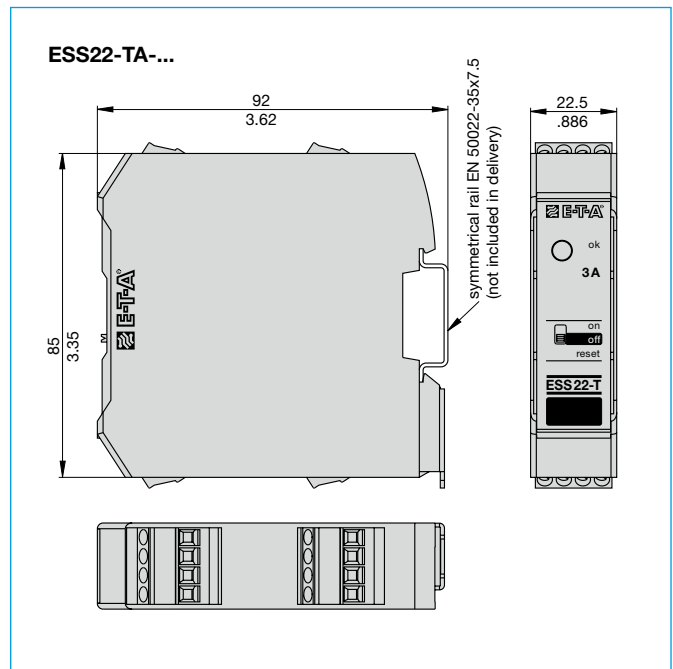

All dimensions without tolerances are for reference only. In the interest of improved design, performance and cost effectiveness the right to make changes in these specifications without notice is reserved. Product markings may not be exactly as the ordering codes. Errors and omissions excepted.

## Terminal wiring diagrams ESS22-TA-... (Example)

**ESS22-TA-000-DC 24 V-xxx A**

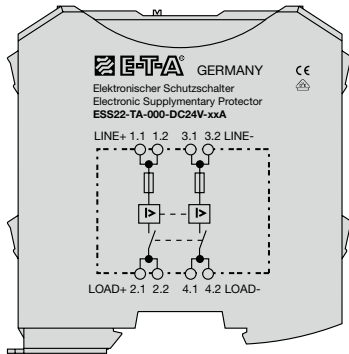

**ESS22-TA-011-DC 24 V-xxx A**

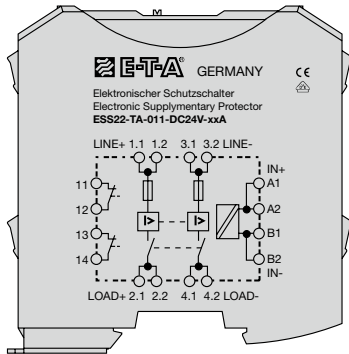

**ESS22-TA-031-DC 24 V-xxx A**

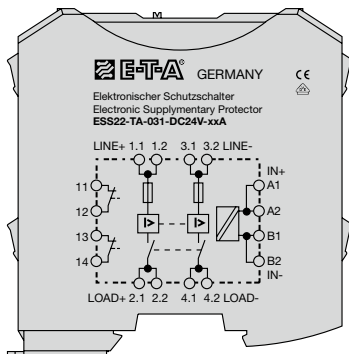

## Terminal connection

Example:

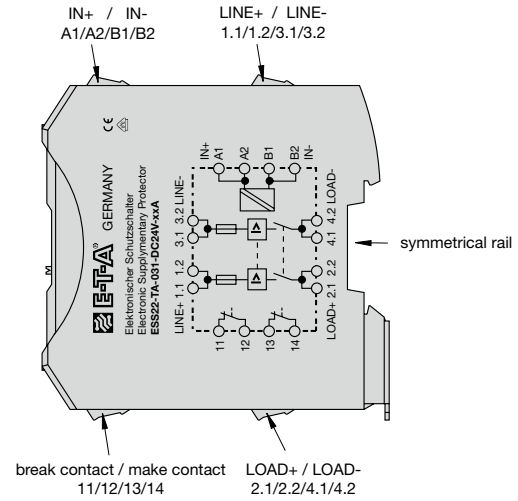

4